

# DRŽÁKY VÝPLNÍ

AISI 304 - BRUS 240

## IS DRŽÁK VÝPLNĚ - KOLMÝ PRO JEKL

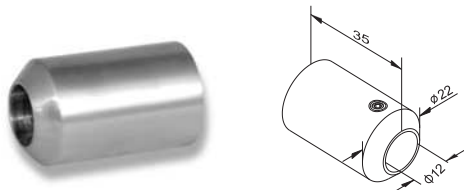

Obj. číslo	Produkt ozn.	Ø	Cena
S22640	BH022.000	□	59,-

## IS DRŽÁK VÝPLNĚ - KOLMÝ PRO TRUBKU

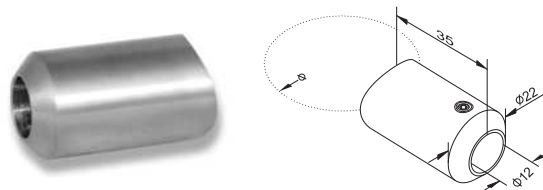

Obj. číslo	Produkt ozn.	Ø	Cena
S22641	BH022.042	42.4	59,-

## IS DRŽÁK VÝPLNĚ NASTAVITELNÝ - PRO JEKL

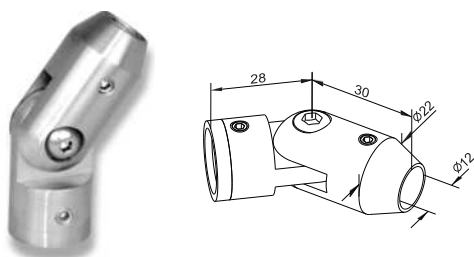

Obj. číslo	Produkt ozn.	Ø	Cena
S22642	BH322.000	□	199,-

## IS DRŽÁK VÝPLNĚ NASTAVITELNÝ - PRO TRUBKU

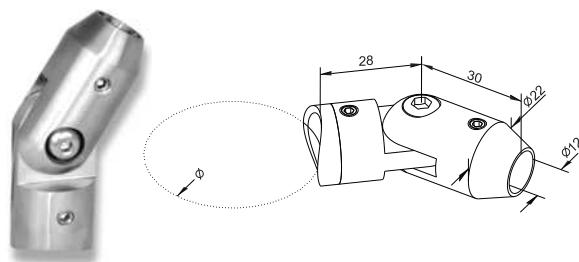

Obj. číslo	Produkt ozn.	Ø	Cena
S22643	BH322.042	42.4	199,-

## IS DRŽÁK PLECHU - PRO JEKL



Obj. číslo	Produkt ozn.	Ø	Cena
S22632	SH025.000	□	139,-

## IS DRŽÁK PLECHU - PRO TRUBKU

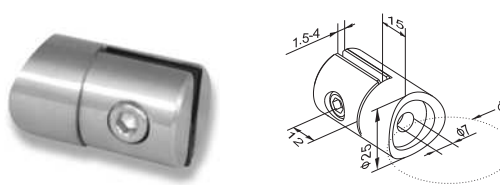

Obj. číslo	Produkt ozn.	Ø	Cena
S22633	SH025.042	42.4	139,-

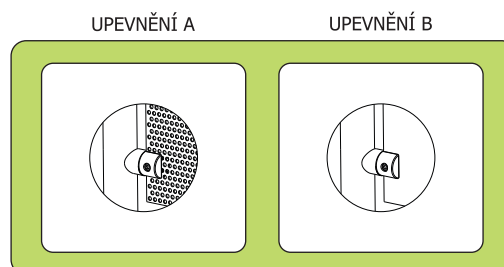
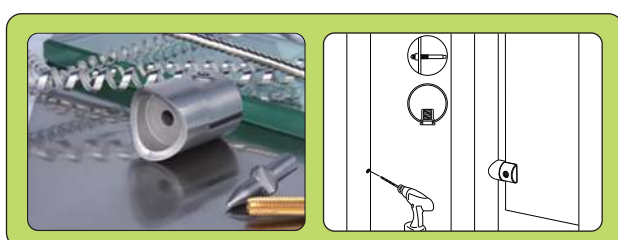

Uvedené ceny jsou v Kč a bez DPH. Změna cen a provedení komponentů vyhrazena.

# ZÁSLEPKY



# ZÁSLEPKY



# ZÁSLEPKY

AISI 304 - BRUS 240

## IS ZÁSLEPKA - VYDUTÁ

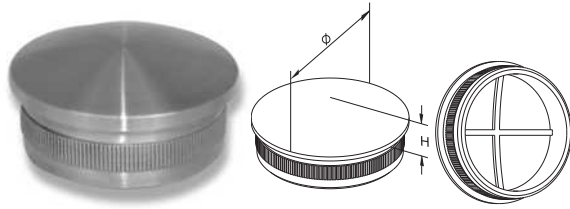

Obj. číslo	Produkt ozn.	H	Ø	Cena
S22646	ECH120.033	6	33.7x2.0	65,-
S22647	ECH120.042	6	42.4x2.0	55,-
S22648	ECH120.048	6	48.3x2.0	79,-

## IS ZÁSLEPKA - VYDUTÁ SE ZÁVITEM

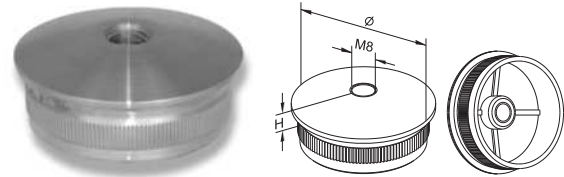

Obj. číslo	Produkt ozn.	H	Ø	Cena
S22649	ECTH120.042	6	42.4x2.0	69,-

## IS ZÁSLEPKA - PŮLKULATÁ

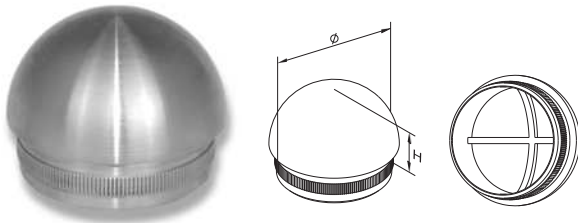

Obj. číslo	Produkt ozn.	H	Ø	Cena
S22652	ECH320.033	16.85	33.7x2.0	79,-
S22653	ECH320.042	21.2	42.4x2.0	89,-
S22654	ECH320.048	24.15	48.3x2.0	109,-

## IS ZÁSLEPKA - ROVNÁ SE ZÁVITEM

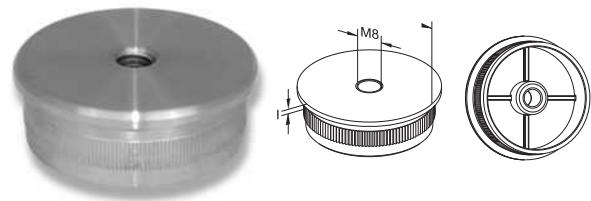

Obj. číslo	Produkt ozn.	H	Ø	Cena
S22650	ECTH220.042	3	42.4x2.0	95,-
S22651	ECTH220.048	3	48.3x2.0	119,-

## IS ZÁSLEPKA - PRO JEKL

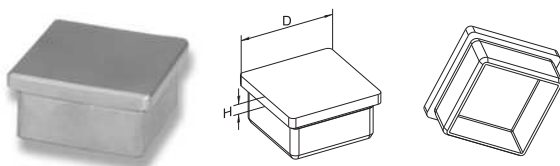

Obj. číslo	Produkt ozn.	H	D	Cena
S22655	ECH1220.040	4	40x40x2.0	85,-

## IS ZÁSLEPKA - PRO JEKL SE ZÁVITEM

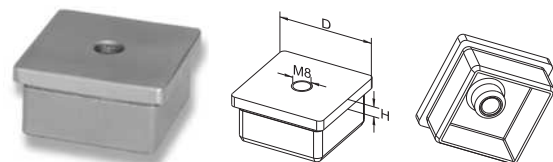

Obj. číslo	Produkt ozn.	H	D	Cena
S22656	ECH1320.040	4	40x40x2.0	95,-

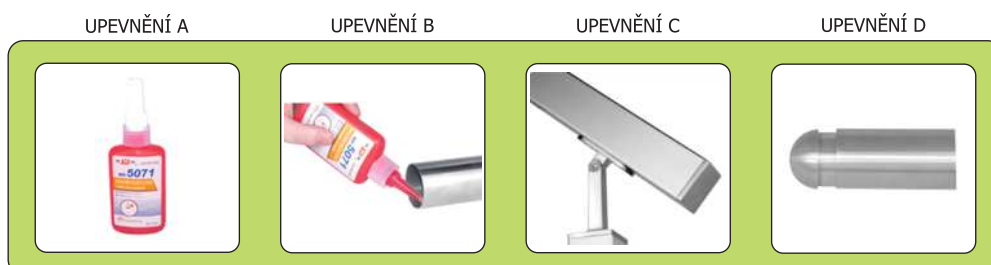

Uvedené ceny jsou v Kč a bez DPH. Změna cen a provedení komponentů vyhrazena.

# ZÁSLEPKY

AISI 304 - BRUS 240

## IS ZÁSLEPKA - PŮLKULATÁ

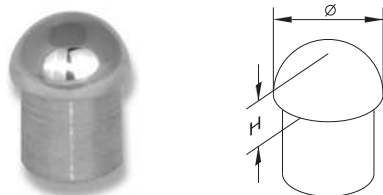

Obj. číslo	Produkt ozn.	Ø	H	Cena
S22657	EB612.012	12x1.0	6	25,-

## IS KOULE SE ZÁVITEM

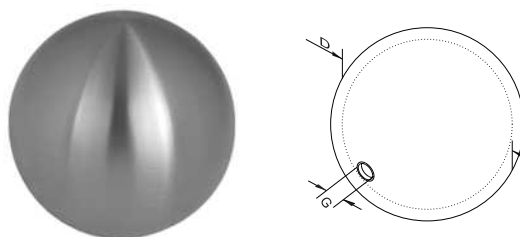

Obj. číslo	Produkt ozn.	D	G	Cena
S22699	EBH050.M8	50	M8	165,-
S22700	EBH080.M8	80	M8	289,-

## IS KOLENO UKONČOVACÍ - OBLÉ

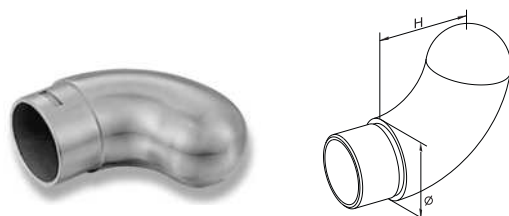

Obj. číslo	Produkt ozn.	Ø	H	Cena
S22930	ECH1520.042	42.4x2.0	65	275,-

## IS ADAPTÉR MADLA

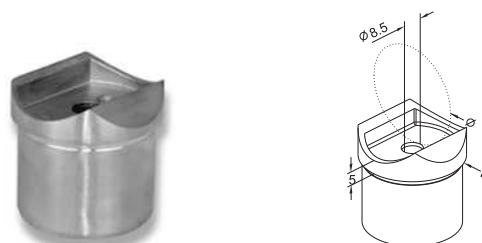

Obj. číslo	Produkt ozn.	D	Ø	Cena
S22986	HA120.033	33.7x2.0	33.7	79,-
S22987	HA120.042	42.4x2.0	42.4	99,-

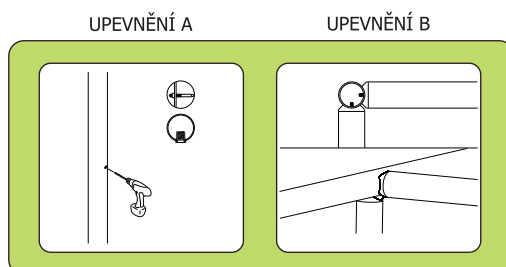

Uvedené ceny jsou v Kč a bez DPH. Změna cen a provedení komponentů vyhrazena.

# KONCOVKY VÝPLNÍ

AISI 304 - BRUS 240

## IS KONCOVKA VÝPLNĚ - OBLÁ (DOPORUČUJEME)

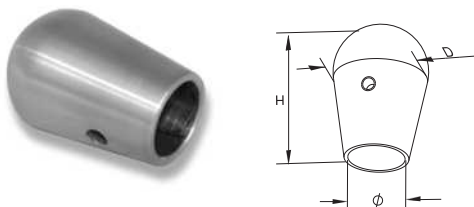

Obj. číslo	Produkt ozn.	D	Ø	H	Cena
S22688	EB030.010	30	10	20	39,-
S22689	EB030.012	30	12	20	45,-

## IS KONCOVKA VÝPLNĚ 12X12

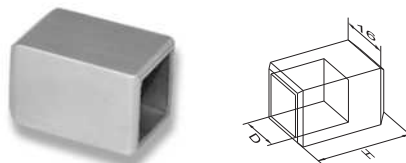

Obj. číslo	Produkt ozn.	D	H	Cena
S22692	EB112.012	12	25	55,-

## IS KOCOVKA VÝPLNĚ - KOULE

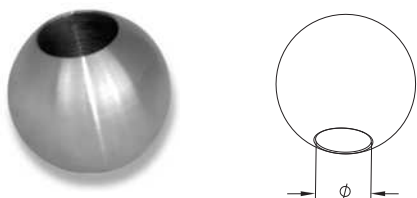

Obj. číslo	Produkt ozn.	D	Ø	Cena
S22693	EB720.010	20	10	35,-
S22694	EB720.012	20	12	39,-

## IS KONCOVKA VÝPLNĚ - BAMBULE

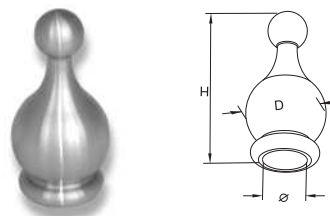

Obj. číslo	Produkt ozn.	D	Ø	H	Cena
S22690	EB225.010	25	10	50	109,-

## IS KONCOVKA VÝPLNĚ - OZDOBNÁ

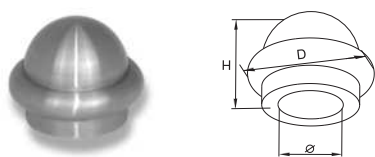

Obj. číslo	Produkt ozn.	D	Ø	H	Cena
S22691	EB420.010	20	10	15	55,-

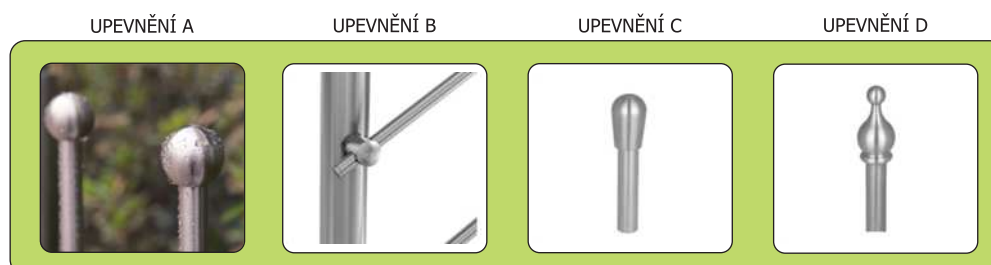

Uvedené ceny jsou v Kč a bez DPH. Změna cen a provedení komponentů vyhrazena.

## DRŽÁKY MADEL - DO SLOUPKŮ



## DRŽÁKY MADEL - DO SLOUPKŮ

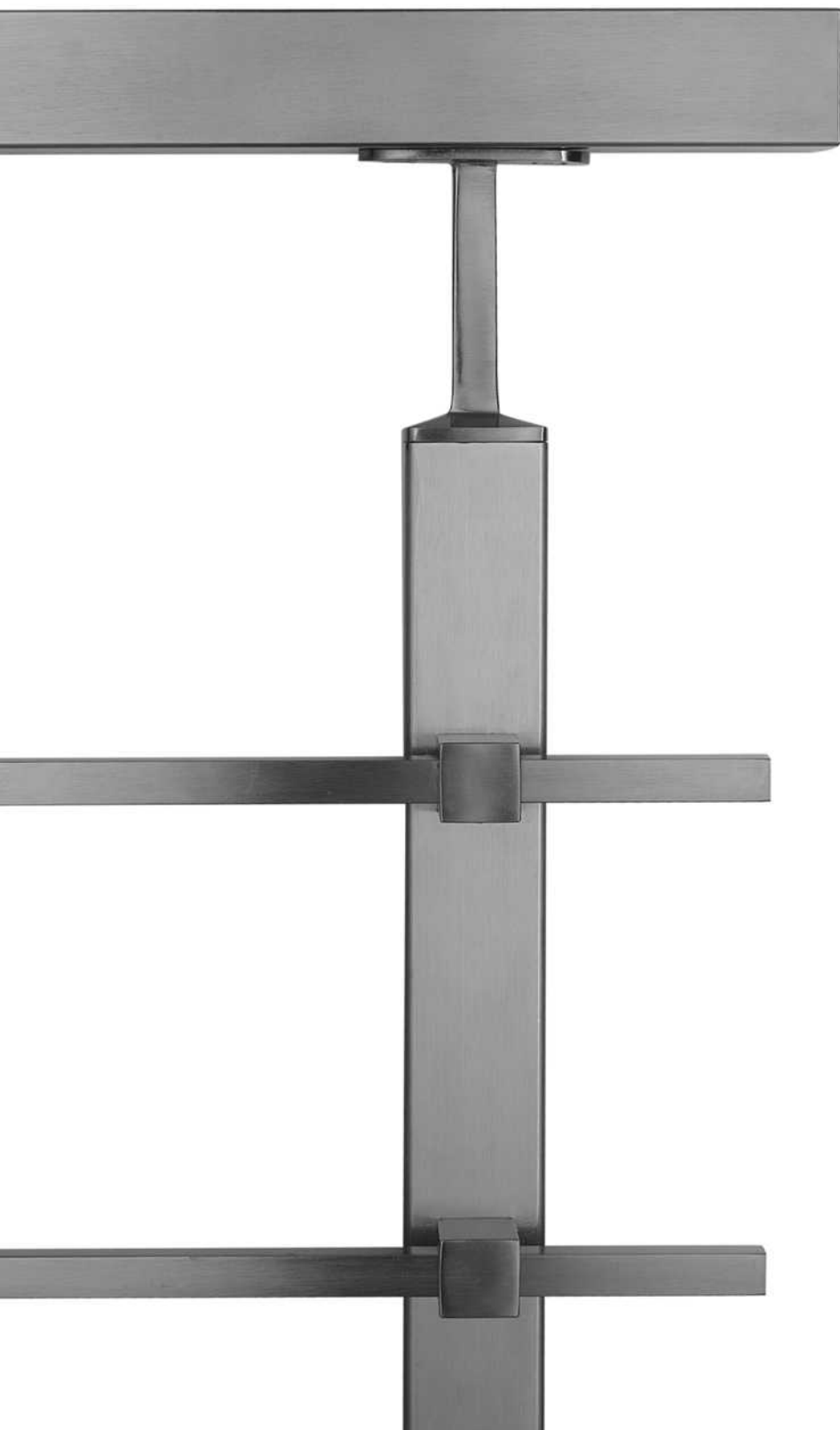



# DRŽÁKY MADEL - DO SLOUPKŮ

AISI 304 - BRUS 240

## IS DRŽÁK MADLA SLOUPKU KONICKÝ - PEVNÝ

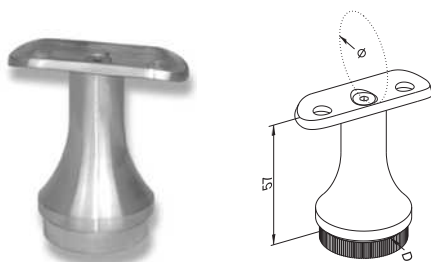

Obj. číslo	Produkt ozn.	D	Ø	Cena
S23001	HS1020.042	42.4x2.0	42.4	189,-
S23002	HS1020.048	48.3x2.0	48.3	219,-

## IS DRŽÁK MADLA SLOUPKU KONICKÝ - KLOBOVÝ

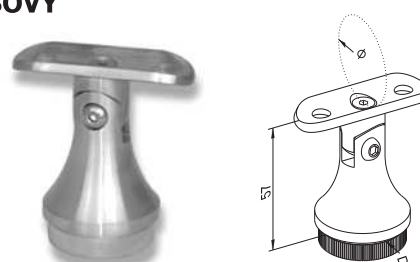

Obj. číslo	Produkt ozn.	D	Ø	Cena
S23003	HS1120.042	42.4x2.0	42.4	219,-
S23004	HS1120.048	48.3x2.0	48.3	259,-

## IS DRŽÁK MADLA SLOUPKU DO JEKLU - PEVNÝ

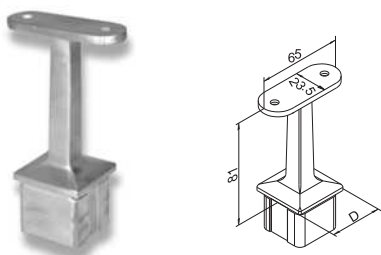

Obj. číslo	Produkt ozn.	Ø	H	Cena
S22966	ST620.040	FLAT	40x40x2	289,-

## IS DRŽÁK MADLA SLOUPKU DO JEKLU - KLOBOVÝ

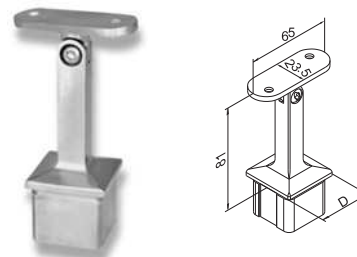

Obj. číslo	Produkt ozn.	D	Cena
S22967	ST820.040	40x40x2	309,-

UPEVNĚNÍ A

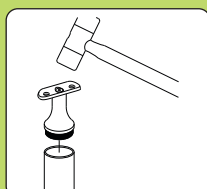

UPEVNĚNÍ B

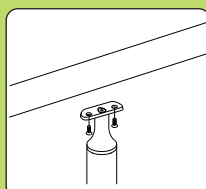

UPEVNĚNÍ C

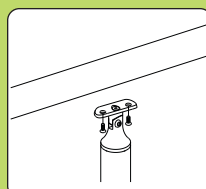

UPEVNĚNÍ A

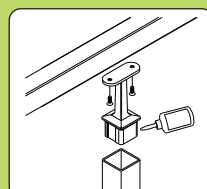

UPEVNĚNÍ B

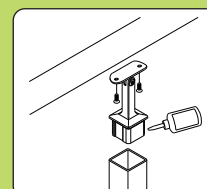

Uvedené ceny jsou v Kč a bez DPH. Změna cen a provedení komponentů vyhrazena.

# DRŽÁKY MADEL - DO SLOUPKŮ

AISI 304 - BRUS 240

## IS DRŽÁK MADLA SLOUPKU S TYČKOU - KLOUB

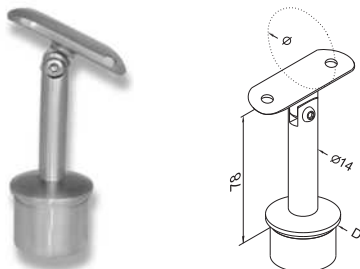

Obj. číslo	Produkt ozn.	D	Ø	Cena
S23000	HS120.042	42.4x2.0	42.4	199,-

## IS DRŽÁK MADLA SLOUPKU S TYČKOU - PEVNÝ

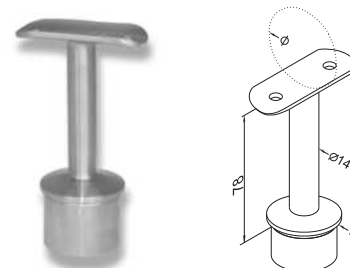

Obj. číslo	Produkt ozn.	D	Ø	Cena
S22999	HS020.042	42.4x2.0	42.4	195,-

## IS DRŽÁK MADLA SLOUPKU S TYČKOU K NAVAŘENÍ

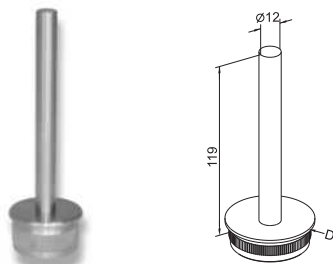

Obj. číslo	Produkt ozn.	D	Cena
S23005	HS1620.042	42.4x2.0	169,-
S23006	HS1620.048	48.3x2.0	209,-

## IS DRŽÁK MADLA SLOUPKU PRO JEKL S TYČKOU K NAVAŘENÍ

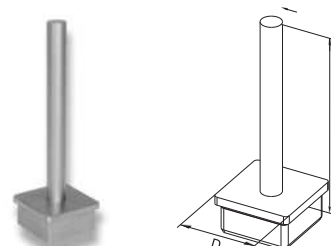

Obj. číslo	Produkt ozn.	D	Cena
S23007	HS1720.040	40x40x2.0	129,-

## IS DRŽÁK MADLA SLOUPKU PRO BOČNÍ UCHYCENÍ

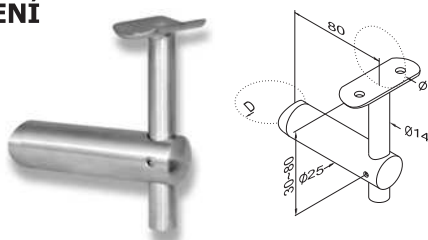

Obj. číslo	Produkt ozn.	D	Ø	Cena
S23027	HB000.042	□	42.4	319,-
S23026	HB042.042	42.4	42.4	309,-

### UPEVNĚNÍ A

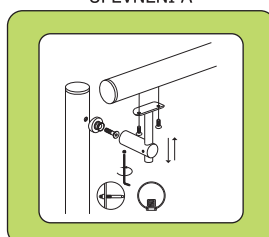

Uvedené ceny jsou v Kč a bez DPH. Změna cen a provedení komponentů vyhrazena.

## DRŽÁKY MADEL - DO ZDI



# DRŽÁKY MADEL - DO ZDI

AISI 304 - BRUS 240

## IS DRŽÁK MADLA NA ZEŽ - IDEÁLNÍ PRO UKOTVENÍ NA CHEMICKOU HMOŽDINKU

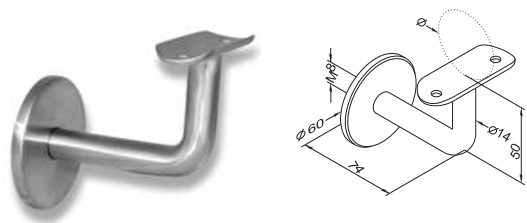

Obj. číslo	Produkt ozn.	Ø	Cena
S23031	HB1200.042	42.4	239,-

## IS DRŽÁK MADLA NA ZEŽ - STAVITELNÝ - IDEÁLNÍ PRO UKOTVENÍ NA CHEMICKOU HMOŽDINKU

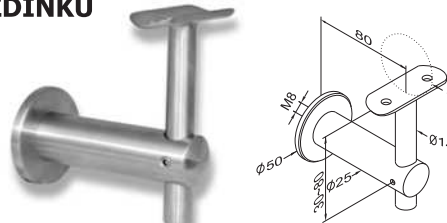

Obj. číslo	Produkt ozn.	Ø	Cena
S23030	HB200.000	□	329,-
S23028	HB200.042	42.4	329,-
S23029	HB200.048	48.3	339,-

## IS DRŽÁK MADLA NA ZEŽ - KLOUB - KOTVENÍ NA HMOŽDINKY

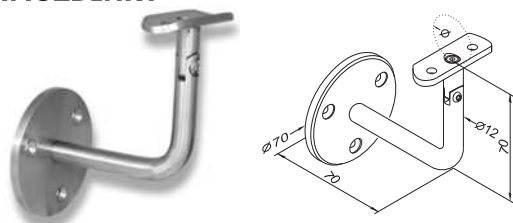

Obj. číslo	Produkt ozn.	Ø	Cena
S23034	HB1700.042	42.4	209,-

## IS DRŽÁK MADLA NA ZEŽ - KOTVENÍ NA HMOŽDINKY

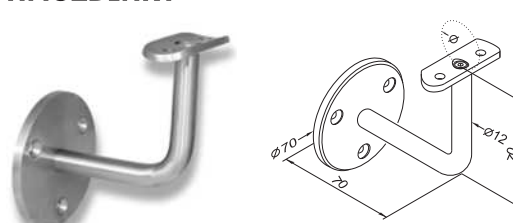

Obj. číslo	Produkt ozn.	Ø	Cena
S23032	HB1600.033	33.7	179,-
S23033	HB1600.042	42.4	179,-

## IS DRŽÁK MADLA NA ZEŽ - VARNÝ - KOTVENÍ NA HMOŽDINKY

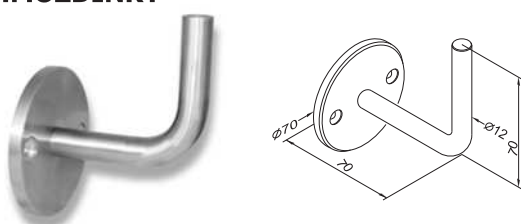

Obj. číslo	Produkt ozn.	Ø	Cena
S23035	HB1800.042	42.4	159,-

Na straně 12-13 si můžete k držákům vybrat krycí rozety

UPEVNĚNÍ A

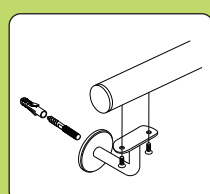

UPEVNĚNÍ B

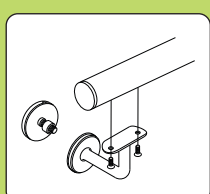

UPEVNĚNÍ C

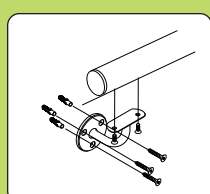

UPEVNĚNÍ A

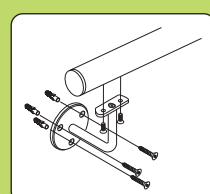

UPEVNĚNÍ B

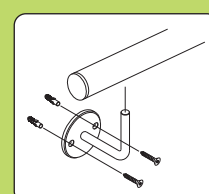

Uvedené ceny jsou v Kč a bez DPH. Změna cen a provedení komponentů vyhrazena.

# DRŽÁKY MADEL - DO ZDI

AISI 304 - BRUS 240

## IS DRŽÁK MADLA PŘÍMÝ - S PRSTENCEM KOTVENÍ NA HMOŽDINKY

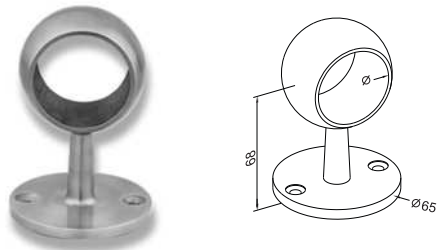

Obj. číslo	Produkt ozn.	Ø	Cena
S23008	HS2000.033	33.7	209,-
S23009	HS2000.042	42.4	219,-
S23010	HS2000.048	48.3	239,-

## IS DRŽÁK MADLA NA ZEŤ 12X12 mm - PEVNÝ

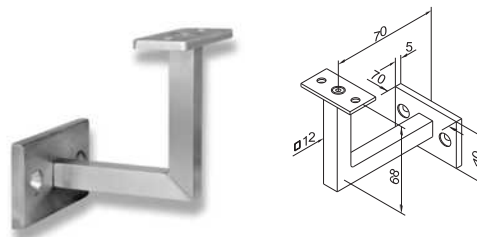

Obj. číslo	Produkt ozn.	Ø	Cena
S23036	HB2200.000	□	199,-

## IS DRŽÁK MADLA NA ZEŤ 12X12 - KLOUB

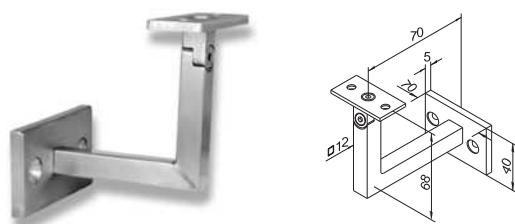

Obj. číslo	Produkt ozn.	Ø	Cena
S23037	HB2300.000	□	269,-

# DRŽÁKY MADEL - PŘÍSLUŠENSTVÍ

AISI 304 - BRUS 240

## IS TYČKA DRŽÁKU MADLA - PEVNÁ

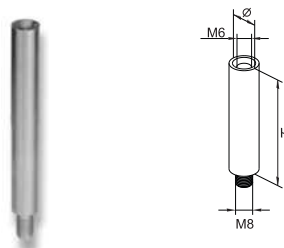

Obj. číslo	Produkt ozn.	H	Ø	Cena
S22976	CB114.068	68	14	49,-

## IS TYČKA DRŽÁKU MADLA - KLOUB

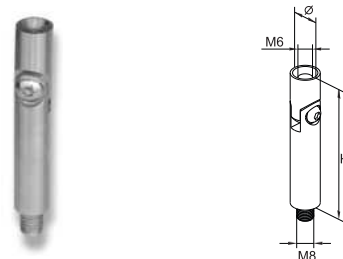

Obj. číslo	Produkt ozn.	H	Ø	Cena
S22977	CB014.068	68	14	99,-

## IS TYČKA 12X12 DRŽÁKU MADLA - PEVNÁ

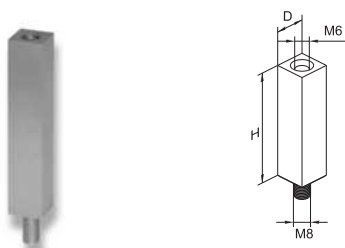

Obj. číslo	Produkt ozn.	H	Ø	Cena
S22978	CB312.068	68	12x12	59,-

## IS TYČKA 12X12 DRŽÁKU MADLA - KLOUB

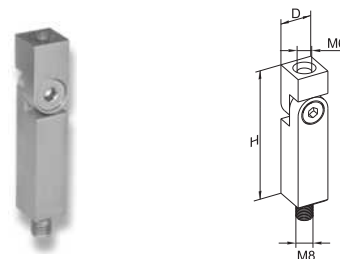

Obj. číslo	Produkt ozn.	H	Ø	Cena
S22979	CB212.068	68	12x12	99,-

## IS TYČKA DRŽÁKU MADLA - ZAHNUTÁ 90°

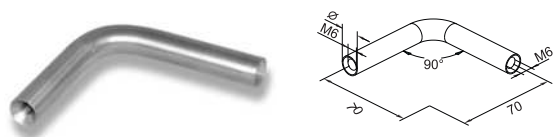

Obj. číslo	Produkt ozn.	Ø	Cena
S22980	CB614.070	14	79,-

## IS PLATLE

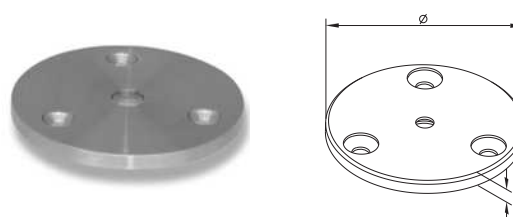

Obj. číslo	Produkt ozn.	H	Ø	Cena
S22988	BP706.070	6	70	99,-

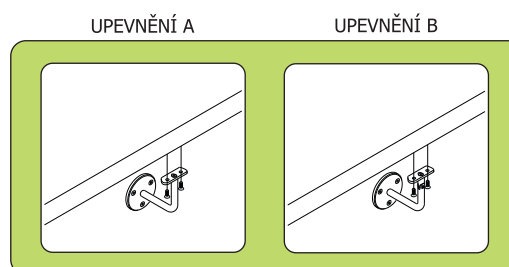
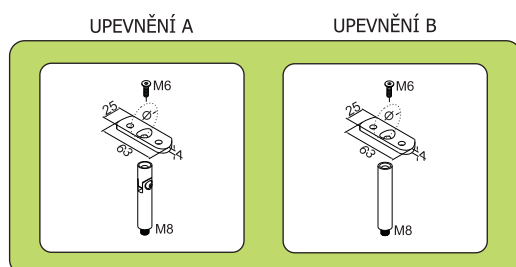

Uvedené ceny jsou v Kč a bez DPH. Změna cen a provedení komponentů vyhrazena.

# DRŽÁKY MADEL - PŘÍSLUŠENSTVÍ

AISI 304 - BRUS 240

## IS PLOCHÁČEK MADLA - NA TRUBKU

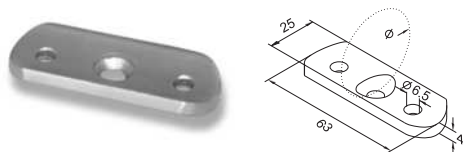

Obj. číslo	Produkt ozn.	Ø	Cena
S22982	S112.033	33.7	39,-
S22983	S112.042	42.4	39,-
S22984	S112.048	48.3	45,-

## IS PLOCHÁČEK MADLA - NA JEKL



Obj. číslo	Produkt ozn.	Ø	Cena
S22981	S012.000	□	39,-

## IS PLOCHÁČEK MADLA - ROHOVÝ

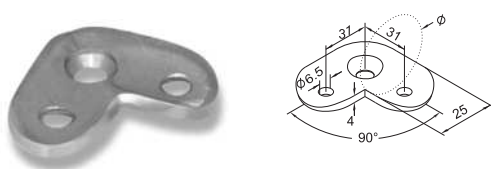

Obj. Číslo	Produkt ozn.	Ø	Cena
S22985	S512.042	42.4	55,-

UPEVNĚNÍ A

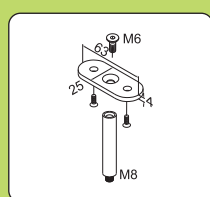

UPEVNĚNÍ B

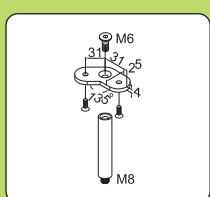

UPEVNĚNÍ C

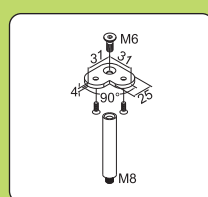

Uvedené ceny jsou v Kč a bez DPH. Změna cen a provedení komponentů vyhrazena.

# DŘEVĚNÁ MADLA + PŘÍSLUŠENSTVÍ

AISI 304 - BRUS 240

## IS MADLO BUK - NELAKOVANÉ

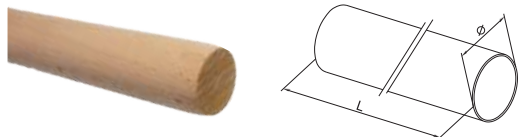

Obj. číslo	Ø	L	Cena
S19636	42.4	2500mm	1190,-

## IS KONCOVKA VYDUTÁ - PRO DŘEVĚNÉ MADLO



1x fixační vložka v ceně

Obj. číslo	Produkt ozn.	Ø	Cena
S23381	R2.4040.042	42.4	139,-

## IS KOLENO OBLÉ 90° - PRO DŘEVĚNÉ MADLO



2x fixační vložka v ceně

Obj. číslo	Produkt ozn.	Ø	Cena
S23378	R2.3230.042	42.4	299,-

## IS KOLENO OSTRÉ 90° - PRO DŘEVĚNÉ MADLO



2x fixační vložka v ceně

Obj. číslo	Produkt ozn.	Ø	Cena
S23379	R2.3120.042	42.4	339,-

## IS KOLENO NASTAVITELNÉ - PRO DŘEVĚNÉ MADLO



2x fixační vložka v ceně

Obj. číslo	Produkt ozn.	Ø	∠	Cena
S23380	R2.3630.042	42.4	90° - 180°	449,-

## IS FIXAČNÍ VLOŽKA - PRO DŘEVĚNÉ MADLO (SAMOSTATNĚ NEPRODEJNÉ)



Uvedené ceny jsou v Kč a bez DPH. Změna cen a provedení komponentů vyhrazena.



Ve spolupráci s českým výrobcem dřevěných madel, Vám jsme schopni na objednávku dodat širokou škálu průřezů dřevěných madel z různých dřevin. Poptávky prosím zasílejte na email [nerez@ripron.cz](mailto:nerez@ripron.cz).

Uvádějte prosím: - typ průřezu

- dřevinu

- délky jednotlivých kusů

- povrchovou úpravu (lakování/bez lakování)

**HL 40**  
**HL 42**  
**HL 45**

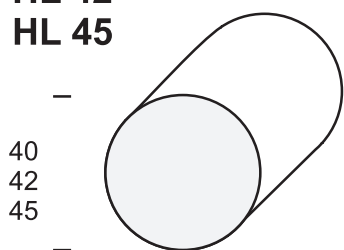

**HL 50**

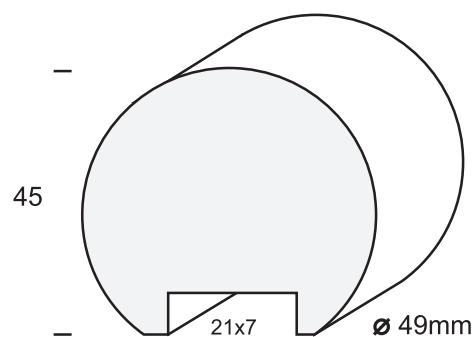

**HLPD 4819**

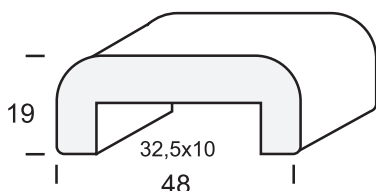

**ABL 25**



**HL 63**  
**HL 63U**

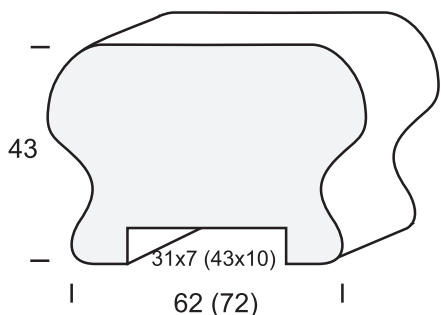

**HL 4540**

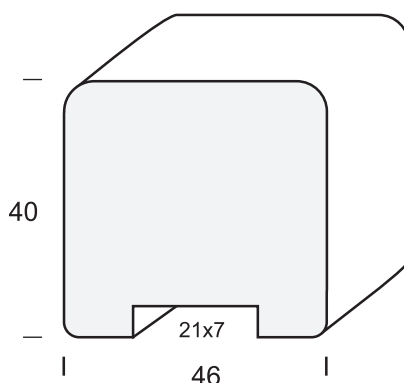

**HL 65**

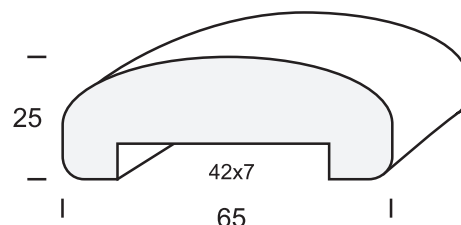

# LEPIDLA, SPRAYE, KOTVY

## IS LEPIDLO - PRO SLEPOVÁNÍ NEREZOVÝCH KOMPONENTŮ



Obj. číslo	Produkt ozn.	BAL.	Cena
S23304	83-21	10 ml	179,-
S23183	83-21	50 ml	479,-

## IS ČISTÍCÍ A KONZERVAČNÍ SPRAY NA NEREZ



Obj. číslo	BAL.	Cena
S15893	400 ml	199,-

## CHEMICKÁ KOTVA PATTEX CF 900



Obj. číslo	Produkt ozn.	Balení	Cena
S11988	CF 900	280ml	269,- *
S11987	CF 900	420ml	290,- *
S03691	Tryska směšovací		16,- *

## IS PŘÍPRAVEK PRO VRTÁNÍ A ŘEZÁNÍ TRUBKY



Obj. číslo	Ø	Cena
S13610	42.4	199,-

## KLEŠTĚ PRO NÝTOVACÍ MATICE 200mm - MALÉ



Obj. číslo	Produkt ozn.	Matice	Cena
S23141	4770620	M3 - M6	658,- *

## KLEŠTĚ PRO NÝTOVACÍ MATICE 330mm



Obj. číslo	Produkt ozn.	Matice	Cena
S23148	4770632	M3 - M10	999,- *

## KLEŠTĚ PRO NÝTOVACÍ MATICE 440mm - SAMO VYSOUVACÍ



Obj. číslo	Produkt ozn.	Matice	Cena
S23144	4770630	M3 - M10	1749,- *

## SVÁŘEČKA KUHTREIBER HF 1500 - VČETNĚ PŘÍSLUŠENSTVÍ



- pro bezdotykové sváření metodou TIG  
- včetně hořáku TIG a redukčního ventilu pro argon

Obj. číslo	Produkt ozn.	Výkon	Cena
S13883	KITin 1500HF	150A	15 990,- *

## KOTOUČ ŘEZNÝ NA NEREZ



Obj. číslo	Rozměry/mm	Cena
S00817	125x1	35,- *
S00831	150x1	39,2 *

## HOUNĚ PRO BROUŠENÍ NEREZU



Obj. číslo	Rozměry/mm	Hrubost	Cena
S00258	250x120	280	29,2,- *
S00257	250x120	180	37,5 *
S00256	250x120	120	37,5 *

## KOTOUČ LAMELOVÝ - BRUSNÝ



Obj. číslo	Rozměry/mm	Hrubost	Cena
S00786	125	60	84,- *
S06372	125	120	84,- *
S00789	150	60	117,- *
S06373	150	120	117,- *

# SPOJOVACÍ MATERIÁL

## PODLOŽKY NEREZ A2



DIN 125



DIN 440

Obj. číslo	DIN	Rozměr/mm	Jednotka	Cena
SA7698	125	6.4	10ks	4,2
S01947	125	8.4	10ks	6,-
SA7699	125	10.5	10ks	10,8
SA7700	125	13.0	10ks	15,8
SA7703	440	6.6	10ks	19,2
SA7704	440	9	10ks	30,-
SA7705	440	11	10ks	46,-
SA7706	440	13.5	10ks	142,-

## MATICE NEREZ A2



DIN 1587



DIN 934

Obj. číslo	DIN	Rozměr	Jednotka	Cena
SA7694	1587	M6	10ks	17,5
SA7695	1587	M8	10ks	42,5
SA7182	1587	M10	10ks	92,5
SA7696	1587	M12	10ks	130,-
SA7688	934	M6	10ks	7,5
SA7689	934	M8	10ks	14,2
SA7690	934	M10	10ks	31,7
SA7691	934	M12	10ks	45,9

## IS NÝTOVACÍ MATICE ZAPUŠTĚNÁ NEREZ A2



Obj. číslo	Závit	Ø	Jednotka	Cena
S19682	M6	9mm	1 ks	14,-
S19553	M8	12mm	1 ks	19,-

# SPOJOVACÍ MATERIÁL

## ŠROUBY NEREZ A2 - METRICKÉ, IMBUS PŮLKULATÁ, ZÁPUŠTNÁ HLAVA



DIN 7380



DIN 7991

Obj. číslo	DIN	Rozměr/mm	Jednotka	Cena
S19196	7380	M5x16	10ks	18,3
S21926	7380	M6x16	10ks	22,-
S21103	7380	M6x25	10ks	25,-
S19924	7380	M6x40	10ks	27,-
S23476	7380	M8x30	10ks	39,-
S17215	7380	M8x60	10ks	79,-
S12956	7991	M6x16	10ks	16,-
S18824	7991	M6x25	10ks	22,-
S12586	7991	M10x50	10ks	149,-

## VRUTY NEREZ A2



DIN 7996



DIN 7997

Obj. číslo	DIN	Rozměr/mm	Jednotka	Cena
S18094	7996	4x40	10ks	16,-
S10145	7996	5x25	10ks	17,-
S21104	7996	5x30	10ks	19,-
S09277	7996	5x50	10ks	26,-
S16814	7996	6x60	10ks	39,-
SA7769	7997	4x40	10ks	11,7
SA0008	7997	5x50	10ks	20,-
S23478	7997	5x80	10ks	29,2
SA0011	7997	6x60	10ks	38,3

## ZÁVITOVÁ TYČ NEREZ A2



Obj. číslo	Závit	L	DIN	Jednotka	Cena
SA7708	M6	1m	975	1ks	31,7
SA7222	M8	1m	975	1ks	54,2
SA2495	M10	1m	975	1ks	75,-
SA7709	M12	1m	975	1ks	113,3

# LANKOVÝ SYSTÉM



# LANKOVÝ SYSTÉM



# LANKOVÝ SYSTÉM

AISI 304 - BRUS 240

## LANKO NEREZ - AISI 316

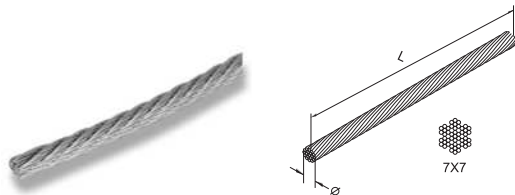

Obj. číslo	Produkt ozn.	Ø	L	Cena/m
S11295	CSC000.040	4.0	1m	29,-
S11295	CSC000.040	4.0	100m	24,-
S09440	CSC000.060	6.0	1m	55,-
S09440	CSC000.060	6.0	100m	45,-

## IS TERMINÁL LANKA - OHEBNÝ, FIXACE NA ČERVÍKY

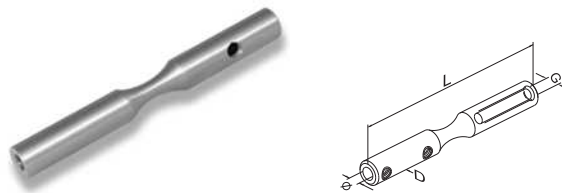

Obj. číslo	Produkt ozn.	Ø	G	L	D	Cena
S23050	CS1040.100	4.0	M6	100	10	49,-
S23051	CS1060.100	6.0	M6	100	12	59,-

## IS TERMINÁL LANKA LISOVACÍ - SAMEC, PRAVÝ ZÁVIT

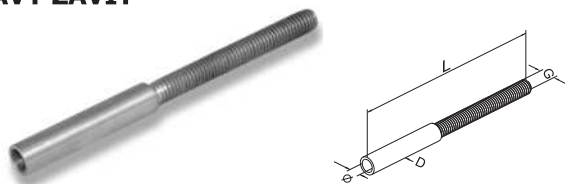

Obj. číslo	Produkt ozn.	Ø	G	L	Cena
S23038	CS940.088	4.0	M6	88	39,-
S23039	CS960.088	6.0	M6	88	49,-

## IS MATICE NAPÍNACÍ P/L ZÁVIT



Obj. číslo	Produkt ozn.	G	L	D	Cena
S23049	CS1310.095	M6	95	10	49,-

Po dohodě další lisovací terminály pro lanka Ø 4, 5, 6, 8 mm a zapůjčení lisu na našich pobočkách.

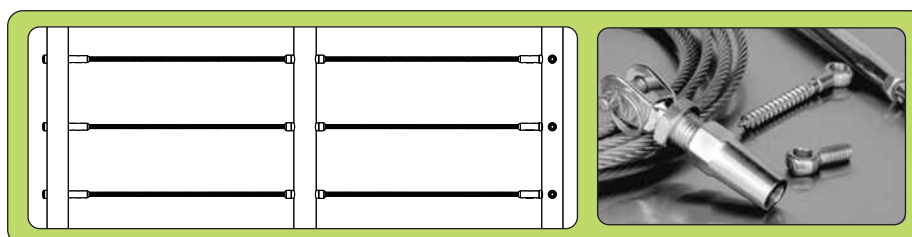

Uvedené ceny jsou v Kč a bez DPH. Změna cen a provedení komponentů vyhrazena.